

# 2MP LightHunter HD IR Fixed Dome Analog Camera

UAC-D122-AF28(40)M



## Overview

UAC-D122-AF28(40)M is a 2MP LightHunter HD IR fixed dome analog camera with a high-performance 1/2.9-inch CMOS sensor and 3D noise reduction technology. It supports TVI/AHD/CVI/CVBS, which effectively enhances product adaptability and diversity of networking solutions. With SYV-75-3 or other coaxial cable types, the camera can achieve low-cost, long-distance, and anti-interference mega-pixel HD video transmission without time delay. It supports IR-cut filter with auto-switch (ICR) and provides color images at daytime and black/white images at night. The camera also supports audio input and synchronous transmission of audio and video.

## Features

- High quality imaging with 2MP resolution
- TVI/AHD/CVI/CVBS
- Supports IR-cut filter with auto-switch (ICR)
- LightHunter monitoring with high-sensitivity sensor
- 3D noise reduction technology delivers clean and sharp images
- Supports 180° horizontal/vertical flip
- OSD configuration menu, easy to operate
- Water and dust resistant (IP67) and vandal-resistant (IK10)
- OSD configuration menu in 11 languages
- Built-in microphone for high quality audio transmission via coaxial cables
- Supports defog
- Metal base and metal housing
- 3-Axis

## Specifications

Model	UAC-D122-AF28M	UAC-D122-AF40M
<b>Sensor</b>		
Pixel	2MP	
Size	1/2.9"	
Minimum illumination	0.005 lux (F1.6, AGC ON) 0 lux (IR on)	
<b>Lens</b>		
Lens	2.8mm	4.0mm
Lens mount	M12	
Angle of view	H: 101.5° V: 56.9° D: 117.4°	H: 83.8° V: 42.7° D: 100.1°
<b>Illuminator</b>		
Illuminator	One IR illuminator	
Illumination distance	30m	
Lifetime	≥60,000 hours	
<b>Video</b>		
Resolution	1080P: 1920(H)×1080(V) 720P: 1280(H) ×720(V)	
Frame rate	TVI: NTSC: 1080P@30fps(default), 720P@30fps PAL: 1080P@25fps, 720P@25fps AHD: NTSC: 1080P@30fps, 720P@30fps PAL: 1080P@25fps, 720P@25fps CVI: NTSC: 1080P@30fps, 720P@30fps PAL: 1080P@25fps, 720P@25fps CVBS: NTSC: 960*480 PAL: 960*576	
Shutter time	NTSC: 1/30s–1/50000s PAL: 1/25s-1/50000s	
<b>Image</b>		
Exposure mode	Four modes: Global (default), BLC, HLC, DWDR	
Day/Night	Three modes: Auto (default), Day, Night	
Noise reduction	2D/3D	
White balance	Two modes: Auto (default), Manual	
WDR	DWDR	
Smart IR	Support	
Flip	Supports 180° horizontal flip, 180° vertical flip	
Defog	Support	
<b>Audio</b>		
Microphone	Built-in Mic	
Camera audio	TVI: 1080P@30fps, 1080P@25fps CVI: 1080P@30fps, 1080P@25fps	

Interface	
Power	5.5mm power interface
Video output	BNC, supports TVI/AHD/CVI/CVBS
Operating environment	
Temperature	-30°C to 60°C (-22°F to 140°F)
Humidity	≤95% (RH, non-condensing)
Surge protection	4kV for power and video output interfaces
Ingress protection	IP67
IK rating	IK10
General	
Power	DC 12V(±25%), with reverse polarity protection, Max 3.3W
Mount	Surface mount (default), optional tilted mounting bracket
Dimensions	Φ109mm*83mm (diameter*height)
Material	Metal
Weight	372g (0.82lb)
Certification	CB, CE, FCC, UL

## Dimensions

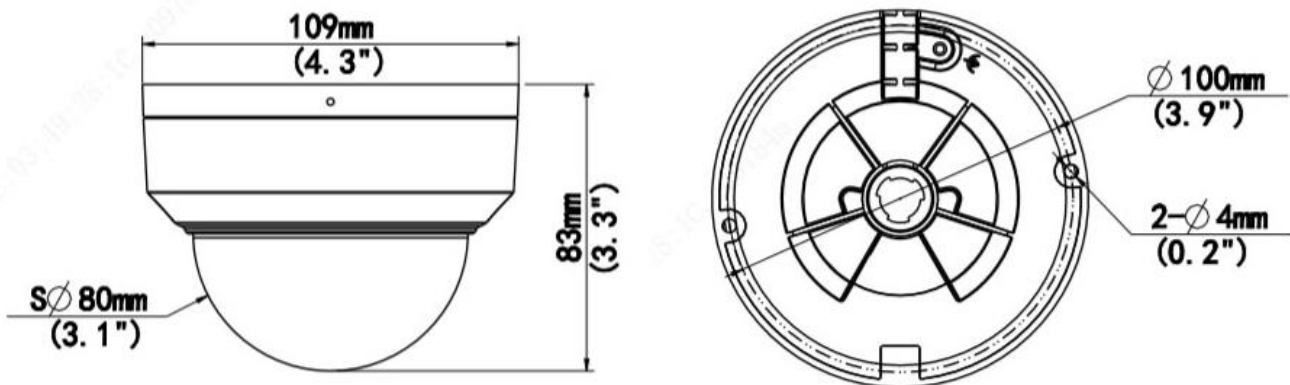

UAC-D122-AF28(40)M

## Accessories

TR-JB03-G-IN  
Junction Box



TR-JB07/WM03-G-IN  
Wall Mount

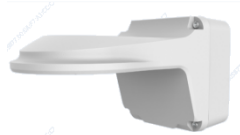

TR-WM03-D-IN  
Wall Mount

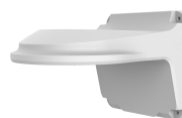

TR-UP06-IN  
Pole Mount



TR-A01-IN  
Waterproof Joint



TR-UC08-C  
Corner Mount

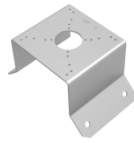

TR-UM06-E-IN  
Tilted Mounting



TR-SE24-IN  
Pendant Mount



TR-CM24-IN  
Pendant Mount



TR-SE24-A-IN  
Pendant Mount



PWR-DC1201A-UK  
Wall Plug-in UK Power  
Adapter



PWR-DC1201A-US  
Wall Plug-in US Power  
Adapter



PWR-DC1201A-EU  
Wall Plug-in EU Power  
Adapter



Mount

TR-JB07/WM03-G-IN

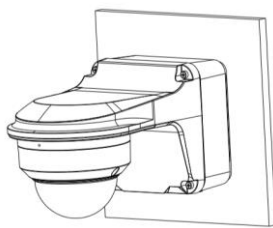

TR-JB03-G-IN

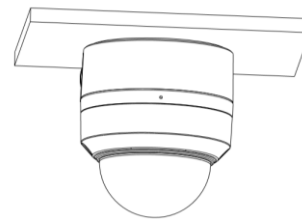

TR-JB07/WM03-G-IN(TR-WM03-D-IN)+TR-UP06-IN

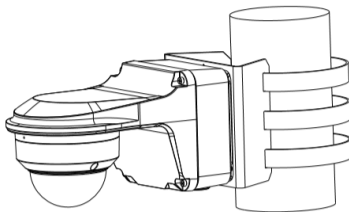

TR-UM06-E-IN

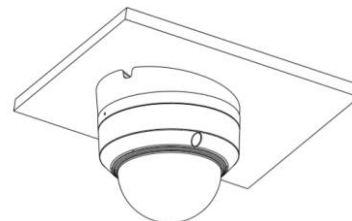

TR-JB07/WM03-G-IN(TR-WM03-D-IN)+TR-UC08-C

TR-CM24-IN+TR-JB03-G-IN

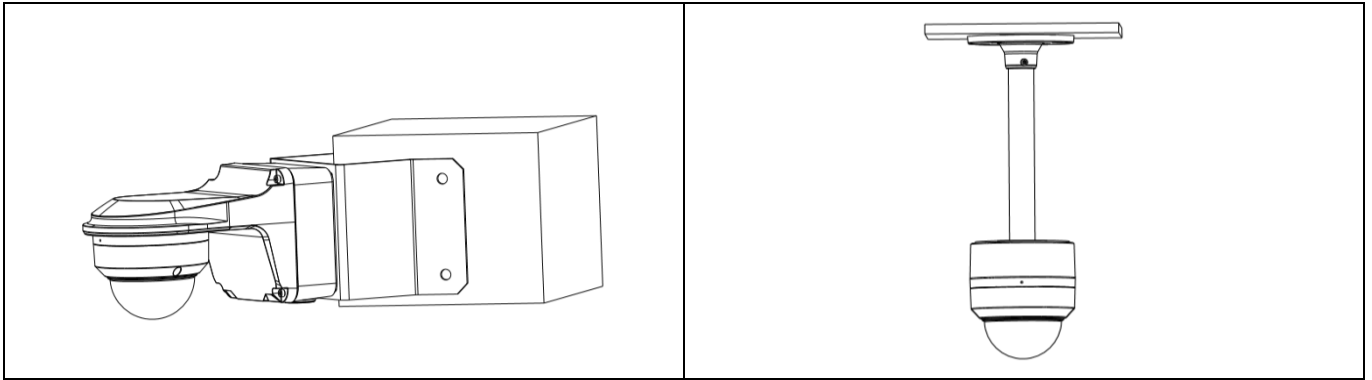

**Zhejiang Uniview Technologies Co., Ltd.**

Building No. 369, Xietong Road, Xixing Sub-district, Binjiang District, Hangzhou City, Zhejiang Province, China (310051)

Email: [overseasbusiness@uniview.com](mailto:overseasbusiness@uniview.com); [globalsupport@uniview.com](mailto:globalsupport@uniview.com)

<https://www.uniview.com>

©2023 Zhejiang Uniview Technologies Co., Ltd. All rights reserved.

\*Product specifications and availability are subject to change without notice.